

**Nissin**  
DIGITAL

Innovation Without Limits



Nissin Digital  
Camera Flash Catalogue

2013  
2014

# POWER PACK PS 8

New  
2013

## EXTERNAL POWER BOOSTER

- For Canon Flash System
- For Nikon Flash System
- For Sony Flash System

### Compact • Lightweight

The core boosting circuit of Nissin Power Pack PS 8 has been redesigned to reduce the heat, compare with previous model, it now uses a high-strength plastic instead of a metal housing for the body. Because of this, the size is now more compact while maintaining the high-performance at the same time.



### Quick-loading battery cartridge

The Nissin Power Pack PS 8 has a new battery cartridge design. In addition to greatly increasing the battery capacity, the new battery design helps to decrease the overall weight.



### Battery level indication LED

When the battery level is less than or equal to 30%, it turns from "green" to "red" and the LED begins "blinking red", this indicates that the battery is nearly discharged.

### High Speed charging

The Power Pack PS 8 provides high speed charging, approximately 0.7s to recharge MG8000 and it can be shot 550 flashes per every full power output (GN 60).<sup>#1</sup>

<sup>#1</sup> Tested with Nissin Power Pack PS 8 full charged battery and MG8000 full charged 4 x LR6 rechargeable batteries.

### USB socket

USB power output which supports DC 5V 2A output. It can be a fast charging device for Image data transfer or others like smartphones and tablet devices in case of any emergency.

### Output sockets

Provides 2 power sockets. Users are able to work with 2 flashes at the same time. A variety of power supply cables are provided for different camera brands.

- External Power Pack Socket in Nissin MG8000/ Di866 Mark II/ Di866/ Di700 flash and MF18 macro flash.

### Operation unit and Accessories



Control Panel



Battery Pack



Charger, Power Cord and Power Supply Cable



Soft Case

### [Specifications of Power Pack PS 8]

Type	For Canon, Nikon and Sony Digital SLR cameras (*1)
Output sockets	Flash external power socket x 2 (Same as PS300), USB (Type A, power output only) x 1
Output voltage	DC 320V
Output Power control	3 levels (high, medium, low)
Flash Charging time	0.5 - 0.7 sec (full power illumination)
Battery type	Ni-MH battery pack
Battery life (Approx.)	550 times (full power output)
Battery level indication LED	LED type (100 - 30%: green, lower than 30%: red, Battery low: blinking red)
Battery loading system	Quick loading cartridge (with two-stage locking device)
USB power output	DC 5V·2A
Accessories	Power Supply Cable, Ni-MH battery pack charger, strap, Soft case
Dimensions	182 (H) x 100 (W) x 38 (D) mm/ 7.2 (H) x 3.9 (W) x 1.5 (D) inches
Weight	710g/ 25oz (with Ni-MH battery pack)

### [Specifications of Ni-MH battery pack]

Type	Cartridge type (with two-stage locking device)
Output voltage	DC 7.2V
Capacity	3,000 mAh
Charging time (Approx.)	4 hours
Charge Discharge cycle (Approx.)	500 cycles
Dimensions	110 (H) x 74 (W) x 27 (D)mm/ 42 (H) x 2.9 (W) x 1 (D) inches (*2)
Weight	386g/ 13.6 oz.



(\*1) Applicable to Pentax with power cord for Nissin PS300  
(\*2) The size is including prominent parts

\*Additional accessories are available for purchase - Power Supply Cable (Canon/ Nikon/ Sony), Nissin PS 8 Power Pack Battery.



# MG8000 EXTREME

## HIGH HEAT RESISTANCE FLASH

- For Canon DSLR Camera
- For Nikon DSLR Camera
- Guide Number [85 (m)/280 (ft)] (ISO 200/105 mm)  
[60 (m)/198 (ft)] (ISO 100/105 mm)



### High Heat Resistance

The high heat resistance materials are developed for this unique model to achieve more than 1,000 times continuum emitting with full flash power without overheating problems.



### Using the latest quartz tube design

Capture the important moments, and reliably in the case of high power and high frequency flash shooting, without concerns about overheating flash effects.

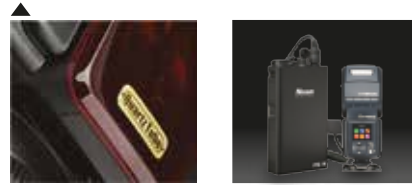

### Equipped with flash diffuser

For full frame digital SLR camera, you can greatly expand the flash illumination angle and also weaken the shadow of the edge from direct flash lighting, suitable for portrait photography.

### Rear curtain sync and High speed shutter

In Rear curtain sync., the flash fires just before the rear curtain closes. By using this function at slow shutter speeds, a moving subject will appear with such moving marks behind.

High speed sync. is recommended for daylight flash photography.

### Combination

High-performance MG8000 with Nissin Power Pack PS 8/ PS300 can speed up the recycle time to achieve high power and frequency of flash photography.

### Quick Loading Battery Magazine

The MG8000 has a battery magazine system which is the same as the Di866. A convenient battery magazine provides all four AA batteries load in the same direction, so that the batteries can be correctly inserted without fail even in the poor light condition.



### Wireless TTL

The MG8000 Wireless TTL system supports Canon E-TTL/ E-TTL II and Nikon i-TTL. MG8000 can be used in combination with Canon and Nikon original flash units as either Master or Remote (Slave).

The MG8000 also supports digital (pre-flash system) and analogue (film type camera's flash and/ or studio strobe under both of Manual and Av. priority mode.

Master Ch 4	
M.Zoom	105 mm
M TTL	+0.3
A M	1/128
B TTL	-0.3
C	--

Wireless TTL-Master Mode (Nikon type)

Remote	
Channel	1
Group	A
M.Zoom	105 mm

Wireless TTL-Remote Mode

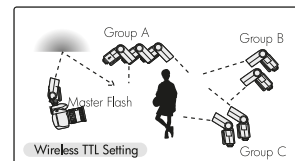

### More Features



#### ● Metal Hotshoe

Durable metal hotshoe design, easy to install and reduce the chance of damage caused by installation.



#### ● Sub-Flash

The MG8000 provides a sub flash below the main flash. This small flash gives a fill-in light while bouncing the main flash. Bouncing the light may shadow the underside of face, and this fill-in flash brightens up the shadow.



#### ● My TTL

TTL exposure level is accurately calibrated for standard balance in accordance with Nissin's standard. If any adjustment is however required, or if you like to set your own preferable level, it can be adjust for about +/- 3EV by every 1/3 EV step.



#### ● External Service Box

- ① External Power Pack Socket – MG8000 supports Nissin Power Pack PS 8/ PS300. The number of flashes is increased and the recycling time is shortened.
- ② PC Sync Terminal – MG8000 has PC sync terminal socket for flash synchronization
- ③ USB Service Port – MG8000 provides a USB port to upgrade to the latest firmware.

E-TTL II  
Canon

i-TTL  
Nikon

1000  
Times  
Full Power

High  
Heat  
Resistance

Quartz  
Tube

Color  
Display

TTL  
Compensation

Manual  
Power  
Ratio

Auto  
Aperture  
Flash

Remote  
Flash  
SD/SF

Wireless  
TTL  
Remote &  
Master

Auto  
Zoom

Bounce  
Lighting

Tilt & Swivel

AF  
Assist  
Light

Silent  
Humming

My  
TTL

Sub  
Flash

Power  
Pack

Sync  
Contact



# MARK II Di866 PROFESSIONAL

HIGH TECH FLASH

- For Canon DSLR Camera
- For Nikon DSLR Camera
- For Sony DSLR Camera
- Guide Number [85(m)/280(ft)] (ISO200/105mm)  
[60(m)/198(ft)] (ISO100/105mm)



E-TTL II  
Canon

i-TTL  
Nikon

ADI,  
P-TTL  
Sony

Color  
Display

TTL  
Compensation

Manual  
Power  
Ratio

Auto  
Aperture  
Flash

Remote  
Flash  
SD/SF

Wireless  
TTL  
Remote &  
Master

Auto  
Zoom

Bounce  
Lighting  
Tilt & Swivel

AF  
Assist  
Light

Silent  
Humming

My  
TTL

Sub  
Flash

Power  
Pack

Sync  
Contact

## Auto Rotation & Color Display

The color display will automatically rotate from horizontal to vertical as the flash is rotated and the user friendly six icon interface represents each of the modes of operation— Auto, TTL, Manual/Av, Multi, Wireless TTL (Master/Remote) and Customer Setting.



## Quick Loading Battery Magazine

The Di866 Mark II has a battery magazine system which is the same as the Di466. A convenient battery magazine provides all four AA batteries load in the same direction, so that the batteries can be correctly inserted without fail even in the poor condition.



## Auto Zoom

Auto Zoom covers 24~105mm focal range. Light diffusing panel covers wide 18mm (35mm format)



## Flash Head

Flash head tilts up to 90° and rotates horizontally 90° to the right and 180° to the left.

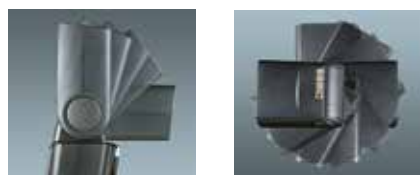

## Digital TTL

TTL: Support Canon E-TTL, E-TTL II, Nikon i-TTL and Sony ADI/ P-TTL. Flash light is automatically controlled by the camera but the flash exposure value can be compensated.

Manual: Flash power can be adjusted manually at 22 levels, from full power to 1/128 power at every 1/3 stops. The appropriate distance to the subject is shown in the display in accordance with the aperture value set on the camera.

Av priority: The flash light can be automatically controlled by the photo sensor built-in the flash unit instead of TTL metering. The F. Stop can be set from F1.4~F16. The distance at the F-stop set on the flash and camera is shown in the display.

Multi Flash: Repeating flash for multi-exposure image in one frame. The power ration can be set from 1/8 to 1/128.

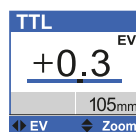

TTL Mode

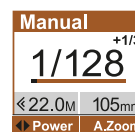

Manual Mode

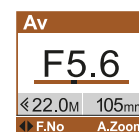

Av priority Mode

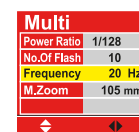

Multi-flash Mode

## Wireless TTL

The Di866 Mark II Wireless TTL system supports Canon E-TTL/ E-TTL II, Nikon i-TTL and Sony ADI/ P-TTL. Di866 Mark II can be used in combination with Canon, Nikon or Sony original flash units as either Master or Remote (Slave).

The Di866 Mark II also supports digital (pre-flash system) and analogue (film type camera's flash and/or studio flash under both of Manual and Av. priority mode.

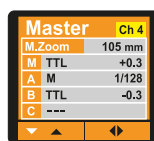

Wireless TTL- Master Mode  
(Nikon type)

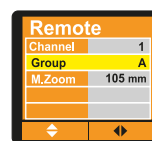

Wireless TTL- Remote Mode

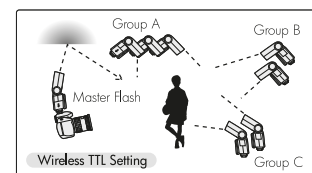

## More Features

- **Metal Hotshoe**  
Durable metal hotshoe design, easy to install and reduce the chance of damage caused by installation.
- **Sub-Flash**  
The Di866 Mark II provides a sub flash below the main flash. This small flash gives a fill-in light while bouncing the main flash. Bouncing the light may shadow the underside of face, and this fill-in flash brightens up the shadow.
- **My TTL**  
TTL exposure level is accurately calibrated for standard balance in accordance with Nissin's standard. If any adjustment is however required, or if you like to set your own preferable level, it can be adjust for about +/- 3 EV by every 1/3 EV step.
- **External Service Box**
  - ① External Power Pack Socket – Di866 Mark II supports Nissin Power Pack PS 8/ PS300. The number of flashes is increased and the recycling time is shortened.
  - ② PC Sync Terminal – Di866 Mark II has PC sync terminal socket for flash synchronization.
  - ③ USB Service Port – Di866 Mark II provides a USB port to upgrade to the latest firmware.



\* Additional accessories are available for purchase - Battery Magazine BM-01, Nissin Power Pack PS 8.



# Di700

## HIGH-PERFORMANCE ADVANCED FLASH

- For Canon DSLR Camera
- For Nikon DSLR Camera
- For Sony DSLR Camera<sup>#2</sup>
- Guide Number [54(m)/177(ft)] (ISO100/200mm)  
[48(m)/157(ft)] (ISO100/105mm)

<sup>#2</sup> Di700 Sony system will be launched later

New  
2013



\*The control panel is synthesized by computer

E-TTL II  
Canon

i-TTL  
Nikon

ADI,  
P-TTL  
Sony

Color  
Display

Selector  
dial

TTL  
Compensation

Manual  
Power  
Ratio

Auto  
Zoom

Remote  
Flash  
SD/SF

Bounce  
Lighting

Tilt & Swivel  
AF  
Assist  
Light

Wireless  
TTL  
Remote

Power  
Pack

Sync  
Contact

## Stylish design with enhanced user experience

The new Nissin Di700 comes with the stylish look; color display panel and selector dial. Even beginners can quickly get started. All settings can be easily operated by one fingertip.

## User Interface

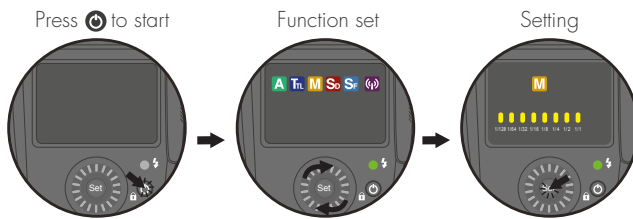

## Selector dial

The Di700 features the use of a selector dial to quickly move through all settings.



## Professional flash head design

It has rotating lock release buttons. Flash head rotates horizontally 180° to right and left, tilts up to 90° and expanded 7° of downward tilt, which is suitable for close up photography. It makes bounce shooting more arbitrary, with more angles that can be used.

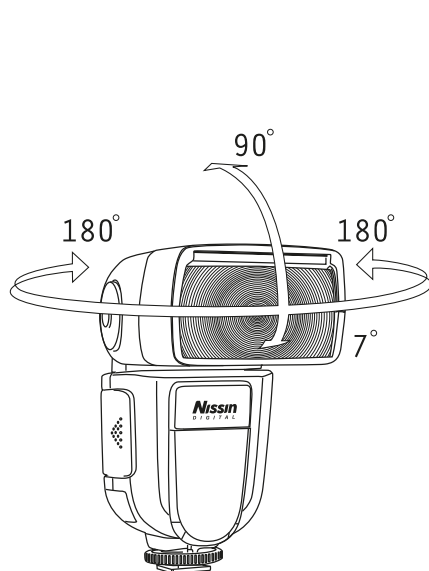

Lock release button



## Wireless TTL Slave

For Canon and Nikon systems: In this mode, Di700 synchronizes to the wireless remote flash system. For remote all channel groups A/B/C in digital flash.

For Sony system: In this mode, Di700 synchronizes to the wireless remote flash system. For remote RMT all channel groups RMT, RMT 1 in digital flash.

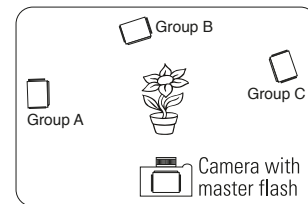

## Focal length range coverage of 24-200mm

The auto zoom coverage has increased to 24~200mm from its predecessor. It can achieve maximum output of GN54 at 200mm.

## More Features

- **Supports high-speed synchronization**  
Support up to 1/8,000 seconds shutter speed.<sup>#3</sup>  
<sup>#3</sup> The shutter speed depending on the camera.
- **Wireless TTL mode**  
Supports Canon E-TTL/ E-TTL II, Nikon i-TTL and Sony ADI/ P-TTL. Various slave settings offer flexible wireless flash combination.
- **External Service Box**
  - ① External Power Pack Socket - The Di700 supports Nissin Power Pack PS 8/ PS300. The number of flashes is increased and the recycling time is shortened.
  - ② The Di700 has Standard & 3.5mm PC sync terminal sockets are built-in for flash synchronization.
- **Battery Magazine - BM - 02**  
The new design of battery magazine perfectly matches with the stylish look of the Nissin Di700.



\*Additional accessories are available for purchase - Battery Magazine BM-02, Nissin Power Pack PS 8.



# Di600

## ADVANCE LEVEL FLASH

- For Canon DSLR Camera
- For Nikon DSLR Camera
- Guide Number [62(m)/205(ft)] (ISO200/105mm)  
[44(m)/145(ft)] (ISO100/105mm)

New  
2013



E-TTL II  
Canon

### Remote Flash

The wireless remote flash system of the Di600 can be used as Wireless TTL remote response to Channel 1 Group A on Master flash. Slave Digital (SD) for digital pre flash system and Slave film (SF) for analogue flash system. You can place numbers of flashes (called slave flash) to light up the subject from multiple directions.



i-TTL  
Nikon

TTL  
Compensation

Manual  
Power Ratio

AF  
Assist Light

Auto  
Zoom

Bounce  
Lighting

Tilt & Swivel

My  
TTL

Sync  
Contact

Wireless  
TTL Remote

Remote  
Flash SD/SF



### High Power

Di600 can brighten up the subject at 11 meters (36 ft.) away at F4, whereas the flash in the camera can reach 3 meters (9.8ft.) (ref.:ISO 100).

Auto zoom reflector focuses the beam and shoots it to the longer distance. For bounce lighting photography, or when using diffuser, high power is an essential factor.

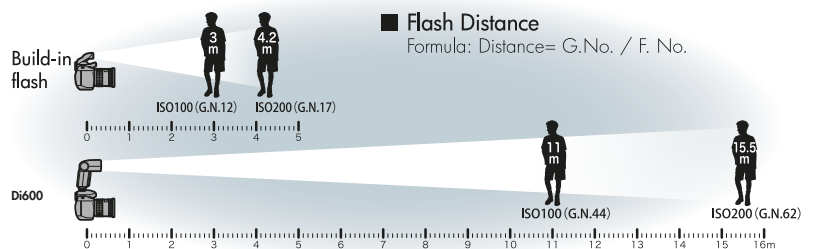

### TTL Compensation

The Di600 can compensate the flash exposure value up to +/- 1.5 EV in 5.0 EV increments. Keeping the exposure value of the back scene, you can adjust the exposure value on main subject only by TTL flash level compensation technology.

### Bounce Lighting

Bouncing the light is another technique to master flash photography. The flash head turns to any direction, 90° to the left, 180° to the right. Use the small fill-in reflector build into the flash head. Bounce the light off the ceiling. A catch light into eye creates an impressive image, and the source of light is changed from the flash to the soft surface light from the ceiling.<sup>#4</sup>

<sup>#4</sup> The color of ceiling may reflect to the subject when bounce lighting.

### More Features

#### • My TTL Setting

TTL exposure level is accurately calibrated for standard balance in accordance with Nissin's standard. If any adjustment is however required, or if you like to set your own preferable level, it can be adjust for about +/- 0.75EV. by every 0.25EV increment. The pre-set "My TTL" is memorized after switching the unit off.

#### • 6 levels manual power control

Manual: Flash power can be adjusted manually at 6 levels, from full power to 1/32 power.

#### • Firmware Update Service Terminal

For latest firmware update

\*\* Please check this service at the local Nissin Distributor or authorized service provider. \*\*

#### • External Synchronization

The Di600 has Standard & 3.5mm PC sync terminal sockets for external flash synchronization.



# Di466

## MULTI FUNCTION FLASH

- For Canon DSLR Camera
- For Nikon DSLR Camera
- For Four Thirds Digital Camera
- Guide Number [46(m)/150(ft)] (ISO100/200mm)  
[33(m)/109(ft)] (ISO100/105mm)



\*Special edition

E-TTL II  
Canon

i-TTL  
Nikon

4/3  
System

M4/3  
System

TTL  
Compensation

Manual  
Power  
Ratio

Remote  
Flash  
SD/SF

Auto  
Zoom

Bounce  
Lighting

Tilt

AF  
Assist  
Light

My  
TTL

### Dual Program Remote Flash

The remote flash system of the Di466 / Di466 Four Thirds can be used as either analogue (single flash) or digital (pre-flash) flash system. Variable power of 6 steps is available. Off camera flash photography offers you a different configuration of lighting image. Use multiple number of Di466 / Di466 Four Thirds and enjoy professional flash technique.



### TTL Compensation

The Di466 / Di466 Four Thirds can compensate the flash exposure value up to +/- 1.5 EV in 0.5 EV increments. Keeping the exposure value of the back scene, you can adjust the exposure value on main subject only by TTL flash exposure level compensation technology.



Flash +1.0EV



Flash ± 0EV



Flash -1.0EV

### Fill-in reflector and Light diffusing panel installed



### Firmware Update Service Terminal

For latest firmware update

\*\* Please check this service at the Nissin Distributor or authorized service provider



### More Features

#### • My TTL Setting

TTL flash power level is pre-set for reasonable exposure. The pre-set "My TTL" is memorized after switch the unit off. The usual TTL flash level compensation works based on this customized level.



#### • Battery Magazine - BM - 01

For quick battery loading, the Di466 / Di466 Four Thirds has a battery magazine system. A convenient battery magazine allows all 4 batteries' to be loaded in the same direction. The batteries can be inserted correctly even in the poor light condition.



# MF18

## MACRO FLASH

### MACRO FLASH

- For Canon DSLR Camera
- For Nikon DSLR Camera
- Guide Number [23(m)/76(ft)] (ISO200/35mm)  
[16(m)/53(ft)] (ISO100/35mm)

- E-TTL II Canon
- i-TTL Nikon
- Color Display
- TTL Compensation
- A:B Ratio Left/Right
- Wireless TTL Master
- Modeling LED
- My TTL
- Power Pack
- Sync Contact

#### Digital TTL

Ring flash MF18 supports Canon E-TTL/ E-TTL II and Nikon i-TTL. Flash light is automatically controlled by the camera and the flash exposure value can be compensated.



#### Wide range of lens mount adaptation

Extendable flash head assort with macro lens mount adaptors from 49 to 82mm. \*Original package included 52, 58, 62, 67, 72 and 77mm (49, 55 and 82mm are optional for purchase).

\*MF18 for Canon / Nikon package

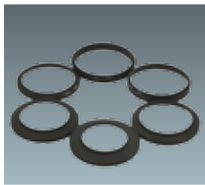

Lens mount adaptors



Expanded

#### User Friendly Color Display

Design of color display with auto rotating from horizontal to vertical as the flash is rotated and the user friendly six icon interface represents each of the modes of operation – Auto, TTL, Wireless TTL (Master), Fine Macro, Manual and Customer Setting.



#### Modeling LED

LED focus lamp with light ratio control, makes it easy to focus on the shooting subject. The brightness reflects flash power ratio setting of left and right, the effect can be previewed.



Modeling LED switch on

#### More Features

##### • Metal Hotshoe

Durable metal hotshoe design, easy to install and reduce the chance of damage caused by installation.



##### • External Service Box

- ① External Power Pack Socket – The Ring flash MF18 supports Nissin Power Pack PS 8/ PS 300. The number of flashes is increased and the recycling time is shortened.
- ② PC Sync Terminal – The Ring flash MF18 has PC Sync Terminal socket for flash synchronization.
- ③ USB Service Port – The Ring flash MF18 provides a USB port to upgrade to the latest firmware.



\*Additional accessories are available for purchase - Battery Magazine BM-01, Nissin Power Pack PS 8.



# Accessories

## Universal Shoe Cord SC-01



Off camera TTL Cord having multi-shoe contacts. This single cord will work with Canon, Nikon, Fujifilm, Pentax and Samsung hotshoe cameras when used with an appropriate dedicated flash.

Length of cord: 30cm/12 inch when folded /  
150cm/59 inch when expanded

## Battery Magazine BM-01



A battery magazine is separately available for MG8000, Di866 Mark II, Di866, Di466 and MF18. Keep one extra with your flash for an easy and quick reloading.

## Battery Magazine BM-02

New  
2013



A battery magazine is separately available for Di700. Keep one extra with your flash for an easy and quick reloading.

## Power Supply Cable (Canon/ Nikon/ Sony)



A power supply cable (Canon/ Nikon/ Sony) is separately available for Nissin Power Pack PS 8/ PS300. Keep one extra with your Power Pack for two flashes at the same time.

## Power Pack Battery - PS 8

New  
2013



A power pack battery is separately available for Nissin Power Pack PS 8. Keep one extra with your Power Pack for an easy and quick reloading.

# Products Specification

		MG8000	Di866 Mark II	Di700
Guide Number	Angle coverage	M / Ft	M / Ft	M / Ft
	24mm	31/102	31/102	22/73
	28mm	36/119	36/119	25/83
	35mm	40/132	40/132	28/92
	50mm	46/152	46/152	32/106
	70mm	52/172	52/172	41/135
	85mm	54/178	54/178	47/155
	105mm	60/198	60/198	48/158
	135mm	—	—	49/162
	200mm	—	—	54/178
Focal Length Coverage (35mm Equiv.)		24~105mm	24~105mm	24~200mm
Wide Angle Diffuser		External Diffuser Included	18mm (Build-in)	16mm (Build-in)
Power Source		4 x AA battery	4 x AA battery	4 x AA battery
		※ Alkaline, NiMH		
Quick Loading System (BM-01/ BM-02)		BM-01	BM-01	BM-02
Recycle Time	NiMH battery	0.1 ~ 5.5 seconds	0.1 ~ 5.5 seconds	0.1 ~ 4 seconds
	Alkaline battery	0.1 ~ 5.5 seconds	0.1 ~ 5.5 seconds	0.1 ~ 4.7 seconds
Number of Flashes		150 ~ 1,500 times	150 ~ 1,500 times	200 ~ 1,500 times
Flash Duration	Manual mode	1/300 (Full Power)	1/300 (Full Power)	1/800 (Full Power)
	TTL mode	1/300 ~ 1/30,000 seconds	1/300 ~ 1/30,000 seconds	1/800 ~ 1/30,000 seconds
Energy Saving	Auto power off	Off, 10, 15, 30, 45, 60 minutes	Off, 10, 15, 30, 45, 60 minutes	60 minutes
	Stand-by mode	30 seconds	30 seconds	A/TTL/M - 2mins, SD/SF/Wireless - 5mins
	Display off	Display screen switch off	Display screen switch off	—
Color Temperature		5,600K	5,600K	5,600K
Flash Power Control System	Full Auto	E-TTL, E-TTL II (for Canon)	E-TTL, E-TTL II (for Canon)	E-TTL, E-TTL II (for Canon)
		i-TTL (for Nikon)	i-TTL (for Nikon)	i-TTL (for Nikon)
	TTL	E-TTL, E-TTL II (for Canon)	E-TTL, E-TTL II (for Canon)	E-TTL, E-TTL II (for Canon)
		i-TTL (for Nikon)	i-TTL (for Nikon)	i-TTL (for Nikon)
	Auto Aperture Flash	EV compensation ± 3.0EV	EV compensation ± 3.0EV	EV compensation ± 2.0EV
		F1.4~F16, 1/3EV steps	F1.4~F16, 1/3EV steps	—
	Manual Power Ratio	Manual zoom, Sub-flash allowed	Manual zoom, Sub-flash allowed	—
		Full ~ 1/128, 1/3EV steps	Full ~ 1/128, 1/3EV steps	Full~1/128, 1/2EV steps
	Multi-flash	Manual zoom, Sub-flash allowed	Manual zoom, Sub-flash allowed	—
		Frequency~90Hz	Frequency~90Hz	—
1~90 times		1~90 times	—	
Wireless Remote	Slave	Digital slave	Digital slave	Digital slave
		Film/ Studio slave	Film/ Studio slave	Film/ Studio slave
Wireless TTL	Master / Remote	4 Channels	4 Channels	All channel Groups A/B/C (Canon/ Nikon)  RMT all channel Groups RMT/RMT1 (Sony)
		CTRL / RMT	CTRL / RMT	
	Canon/Nikon - Groups	Canon/Nikon - Groups: 3 groups (A,B,C)		
	3 groups (A, B, C)	Sony - Groups: RMT, RMT1		
	Modes: Off/ TTL/ Manual	Modes: Off/ TTL/ Manual		
TTL Flash Ratio Adjustable For Canon	TTL Flash Ratio Adjustable For Canon			
Ev Compensation on flash		-3.0~+3.0, 1/3EV steps	-3.0~+3.0, 1/3EV steps	-2.0~+2.0, 1/2EV steps
My TTL Setting		-3.0~+3.0, 1/3EV steps	-3.0~+3.0, 1/3EV steps	—
Bounce Function		Up: 90°, Left/Right: 90°/180°	Up: 90°, Left/Right: 90°/180°	Up: 90°, Down: -7°, Left/ Right: 180°
Sub-flash		Full~1/128	Full~1/128	—
FE/FV Lock		[FEL] OR [*] Button (For Canon) Set FUNC. key as FV lock function in menu (For Nikon)		
Rear curtain sync.		Yes	Yes	Yes
High speed sync.		Yes	Yes	Yes
Red eyes reduction mode (Nikon)		Yes	Yes	Yes
Slow sync. mode (Nikon)		Yes	Yes	Yes
AF Assist Light Distance		0.7 ~ 10m	0.7 ~ 10m	0.7 ~ 6m
Operation Control Panel		Color display (Auto rotation)	Color display (Auto rotation)	Color display (LED)
Firmware update Terminal		USB Terminal	USB Terminal	Exclusive Terminal
PC sync Terminal		Yes	Yes	Yes
External power pack socket		Nissin/ Canon/ Nikon original Power pack	Nissin/ Canon/ Nikon/ Sony original Power pack	Nissin/ Canon/ Nikon/ Sony original Power pack
Accessories		Soft Pouch External Diffuser Flash Stand with Tripod screw	Soft Pouch Flash Stand with Tripod screw	Soft Pouch Flash Stand with Tripod screw
Dimensions (Approx.)		148 x 78 x 127mm/ 5.8 x 3.1 x 5 inch	139 x 74 x 113mm/ 5.5 x 2.9 x 4.4 inch	140 x 75 x 115 mm/ 5.5 x 3 x 4.5 inch
Weight (Approx.)		429grams (15.1oz) w/o battery	391grams (13.8oz) w/o battery	381grams (13.4oz) w/o battery

**Notice: Flashes are not supporting film cameras**

● Design And Specifications Are Subject To Change Without Prior Notice

		Di600	Di466	Di466 Four Thirds	MF18
Guide Number	Angle coverage	M / Ft	M / Ft		M / Ft
	24mm	25/83	18/59		—
	28mm	28/92	20/66		—
	35mm	32/106	22/73		—
	50mm	35/116	24/79		—
	70mm	38/125	27/89		—
	85mm	41/135	30/99		—
	105mm	44/145	33/109		—
	135mm	—	—		—
	200mm	—	—		—
Focal Length Coverage (35mm Equiv.)		24~105mm	24~105mm	12~35mm	—
Wide Angle Diffuser		16mm (Build-in)	18mm (Build-in)	9mm (Build-in)	—
Power Source		4 x AA battery	4 x AA battery		4 x AA battery
		※ Alkaline, NiMH			
Quick Loading System (BM-01/ BM-02)		—	BM-01		BM-01
Recycle Time	NiMH battery	0.1 ~ 4 seconds	0.1 ~ 3.8 seconds		0.1 ~ 5.5 seconds
	Alkaline battery	0.1 ~ 4.7 seconds	0.1 ~ 4.5 seconds		0.1 ~ 5.5 seconds
Number of Flashes	NiMH battery	200 ~ 1,500 times	200 ~ 1,500 times		120 ~ 800 times
Flash Duration	Manual mode	1/800 (Full Power)	1/800 (Full Power)		1/300 (Full Power)
	TTL mode	1/800 ~ 1/30,000 seconds	1/800 ~ 1/20,000 seconds		1/700 ~ 1/30,000 seconds
Energy Saving	Auto power off	60 minutes	30 minutes		30 minutes
	Stand-by mode	2 minutes	2 minutes		30 seconds
	Display off	—	—		Display screen switch off
Color Temperature		5,600K	5,600K		5,600K
Flash Power Control System	Full Auto	—	—		E-TTL, E-TTL II (for Canon)
		—	—		i-TTL (for Nikon)
	TTL	E-TTL, E-TTL II (for Canon)	E-TTL, E-TTL II (for Canon)/ i-TTL (for Nikon)		E-TTL, E-TTL II (for Canon)
		i-TTL (for Nikon)	Four Thirds system		i-TTL (for Nikon)
		EV compensation by camera	Ev compensation ± 1.5EV		Ev compensation ± 3.0EV
	Auto Aperture Flash	—	—		—
Manual Power Ratio	Full ~ 1/32 , 6 levels	Full ~ 1/32 , 6 levels		Manual Full ~ 1/64 -2/3, 1/3 steps Fine Macro 1/128~1/1024, 1/6 steps	
Multi-flash	—	—		—	
Wireless Remote	Slave	Digital slave	Digital slave		—
		Film/ studio slave	Film/ studio slave		—
	Wireless TTL	Channel 1 Groups A (Canon/ Nikon)	—		Master 4 Channels
			—		Canon/ Nikon-Group
			—		Group A/C
		—		Modes: Off/ TTL/ Manual	
		—		TTL Flash Ratio Adjustable For Canon	
Ev Compensation on flash		-1.5~+1.5EV, 1/2EV steps	-1.5~+1.5EV, 1/2EV steps		-3.0~+3.0EV, 1/3EV steps
My TTL Setting		-0.75~+0.75EV, 1/4EV steps	-0.75~+0.75EV, 1/4EV steps		-3.0~+3.0EV, 1/3EV steps
Bounce Function		Up: 90°, Left/ Right: 90/180°	Upward: 90°		—
Sub-flash		—	—		—
FE/FV Lock		[FEL] OR [*] Button (For Canon)			
		Set FUNC. key as FV lock function in menu (For Nikon)			
Rear curtain sync.		Yes	Yes (Nikon/ Four Thirds)		Yes
High speed sync.		—	—		Yes
Red eyes reduction mode (Nikon)		Yes	Yes (Nikon/ Four Thirds)		Yes
Slow sync. mode (Nikon)		Yes (Nikon / Sony)	Yes (Nikon/ Four Thirds)		Yes
AF Assist Light Distance		0.7 ~ 6m	0.7 ~ 6m		Modeling LED for macro focus
Operation Control Panel		LED	LED		Color display (Auto rotation)
Firmware update Terminal		Exclusive Terminal	Exclusive Terminal		USB Terminal
PC sync Terminal		Yes	—		Yes
External power pack socket		—	—		Nissin/ Canon/ Nikon original Power pack
Accessories		Flash Stand with Tripod screw	Soft Pouch Flash Stand with Tripod screw		Hard case Adaptor rings: 52, 58, 62, 67, 72 and 77mm
Dimensions (Approx.)		134 x 74 x 103 mm/ 5.3 x 2.9 x 4.1 inch	105 x 67 x 95 mm/ 4.1 x 2.6 x 3.7 inch		Main body: 115 x 65 x 85mm/ 4.5 x 2.6 x 3.3 inch Ring flash: 120 x 134 x 41mm/ 4.7 x 5.3 x 1.6 inch
Weight (Approx.)		315grams (11.1oz) w/o battery	238grams (8.4oz) w/o battery		458grams (16.2oz) w/o battery

# Nissin

Nissin Marketing Ltd.

Tel: (852) 2880 5050

Email: [info@nissin.com.hk](mailto:info@nissin.com.hk)



- Design And Specifications Are Subject To Change Without Prior Notice
- See [www.nissindigital.com](http://www.nissindigital.com) for more information.



ENG.Rev.3.0\_102013

Local Distributor: